



Idler Wheel Rollers



BLACK ACE® IDLER WHEEL ROLLERS

Today's equipment is evolving at a rapid pace. Equipment sizes and speeds are growing beyond imagination. Demands on components have increased, and failure is not an option. Black Ace Idler Wheel Rollers are designed to take the loads and strains of today's new drives. Production and dependability are key components to successful and profitable operations. Black Ace Idler Wheels will keep your equipment rolling.



Flat Series - Steel
page 3 - 7



Flat Series - Rubber
page 9 - 12



Urethane Rollers
page 13 - 14



Tapered Edge Series - Steel
page 15 - 16



Flanged Series - Steel
page 17 - 20



Flanged Series - Rubber
page 21 - 23



Double Flanged Series - Steel
page 25 - 26



Cone Series - Steel
page 27 - 29

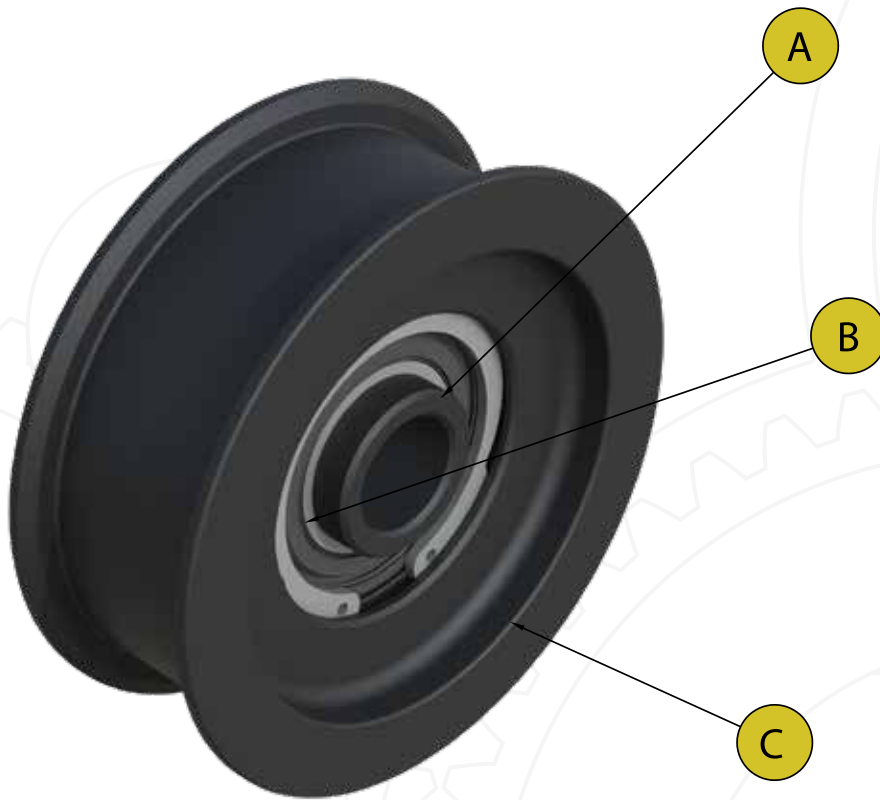

A. The Standoff - Where Roller Meets Machine

- Precision machined steel. Bolt on with confidence.
- Limitless options of lengths and diameters means your application will mount to perfection. Say goodbye to washers.

B. The Black Ace Bearing - The Heart of the Roller

- Larger than the industry standard. This means higher loads and longer bearing life. Multiple stacked bearings available for extreme loads.
- Superior seal construction. Contaminating environments greatly reduce bearing life. Black Ace seals protect the bearing's interior from the harsh environments to increase bearing life dramatically.
- Specially formulated grease. Lubrication is vital to bearings. This grease is designed for high loads and speeds to reduce wear.

C. The Body - The Worker

- Precision machined. Concentricity and fit are completely controlled.
- Endless styles and profiles. If we haven't made it yet, we can.
- Multiple materials to choose from: Steel, Hardened Steel, Rubber-to-Steel Bonded, Cast Iron, and Urethane.
- Replaceable bearings - If your bearing does fail, it can easily be replaced.

KEEP YOUR EQUIPMENT ROLLING.

FLAT SERIES - STEEL

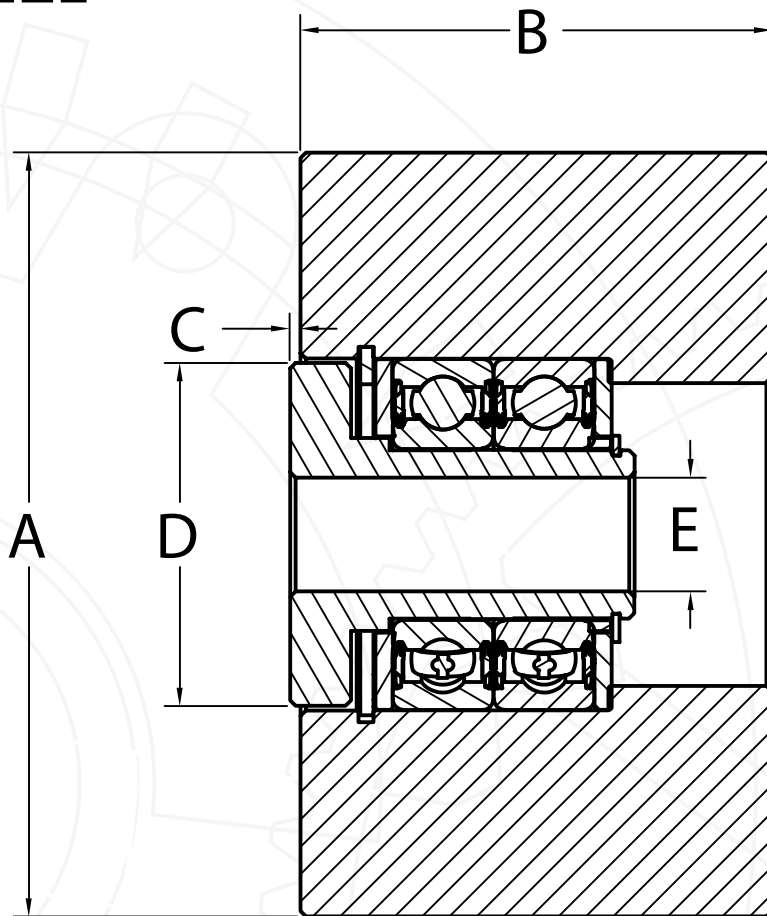

- A: Wheel Diameter
- B: Wheel Width
- C: Standoff Length
- D: Standoff Diameter
- E: Through Hole

BEARING INFORMATION

BGA - A 52MM (6205) Bearing used in high speed applications

BGAS - A 52MM (6205) Bearing used in low to moderate speed applications where high contamination is present

BGF - A 52MM Collar locking bearing used in low to moderate speed applications where moderate contamination is present (used only for 1" shaft mounts)

BGBS - A 40MM (6203) Bearing used in low to moderate speed applications where high contamination is present

BGB - A 40MM (6203) Bearing used in high speed applications





NB21 - A fixed bearing used in underwater applications

AUXILIARY SEAL INFORMATION

NRT - An auxiliary bearing seal that provides excellent protection in high contamination areas to greatly improve bearing life. The NRT seal has a low friction coefficient, providing low bearing drag.

	PART NUMBER	WHEEL DIAMETER	WHEEL WIDTH	STANDOFF LENGTH	STANDOFF DIAMETER	THROUGH HOLE	BEARING	AUXILIARY SEAL	APPLICATION
		A	B	C	D	E			
	RA200MN	2"	1"	.062 OR .094	3/4"	1/2"	(1) BGBS	N/A	Moderate Contamination
	RA225MN	2-1/4"	1"	.062 OR .094	3/4"	1/2"	(1) BGBS	N/A	Moderate Contamination
	RA250MN	2-1/2"	1"	.062 OR .094	3/4"	1/2"	(1) BGBS	N/A	Moderate Contamination
	R2517BRBW1	2-1/2"	1-3/4"	0.06	1-1/8"	1/2"	(2) BGAS	(2) NRT	High Contamination
	R25BR/BRG	2-1/2"	2-3/8"	N/A	N/A	N/A	(2) BGAS	(2) NRT	High Contamination
	R25BRM2	2-1/2"	2-3/8"	0.97	2"	5/8"	(2) BGAS	(2) NRT	High Contamination
	R25BRMM2	2-1/2"	2-3/8"	0.74	1-3/4"	5/8"	(2) BGAS	(2) NRT	High Contamination
	R25BRR1	2-1/2"	2-3/8"	0.06	2"	1/2"	(2) BGAS	(2) NRT	High Contamination
	R25BRR2	2-1/2"	2-3/8"	0.06	2"	5/8"	(2) BGAS	(2) NRT	High Contamination
	R25BRR3	2-1/2"	2-3/8"	0.06	2"	3/4"	(2) BGAS	(2) NRT	High Contamination
	R25BRU1	2-1/2"	2-3/8"	0.06	1-3/8"	1/2"	(2) BGAS	(2) NRT	High Contamination
	R25BRU2	2-1/2"	2-3/8"	0.06	1-3/8"	5/8"	(2) BGAS	(2) NRT	High Contamination
	2625BG2	2-1/2"	4-1/8"	0.06	1-1/8"	5/8"	(2) BGA	----	High Speed
	2625BG3	2-1/2"	4-1/8"	0.06	1-1/8"	3/4"	(2) BGA	----	High Speed
	2625LBGL2	2-1/2"	4-1/2"	0.06	1-1/8"	5/8"	(2) BGA	----	High Speed
	2625LBGL3	2-1/2"	4-1/2"	0.06	1-1/8"	3/4"	(2) BGA	----	High Speed
	550007	2-1/2"	8"	.3 (Both Sides)	1-1/8"	3/8-16 Tapped	(2) BGA	----	High Speed
	R31AB1	3"	1"	0.13	1-1/8"	1/2"	(1) BGAS	N/A	Moderate Contamination
	R31AB2	3"	1"	0.13	1-1/8"	5/8"	(1) BGAS	N/A	Moderate Contamination
	R31AB3	3"	1"	0.13	1-1/8"	3/4"	(1) BGAS	N/A	Moderate Contamination
	R31AJ1	3"	1"	0.48	1-3/8"	1/2"	(1) BGAS	N/A	Moderate Contamination
	R31AJ2	3"	1"	0.48	1-3/8"	5/8"	(1) BGAS	N/A	Moderate Contamination
	R31AL1	3"	1"	1.108	1-1/2"	1/2"	(1) BGAS	N/A	Moderate Contamination
	R31AL2	3"	1"	1.108	1-1/2"	5/8"	(1) BGAS	N/A	Moderate Contamination
	R31AW1	3"	1"	0.2	1-3/8"	1/2"	(1) BGAS	N/A	Moderate Contamination
	R31AW2	3"	1"	0.2	1-3/8"	5/8"	(1) BGAS	N/A	Moderate Contamination
	R31AY1	3"	1"	2.06	1-1/2"	1/2"	(1) BGAS	N/A	Moderate Contamination
	R31AY2	3"	1"	2.06	1-1/2"	5/8"	(1) BGAS	N/A	Moderate Contamination
	R31A/BRG	3"	1"	N/A	N/A	N/A	(1) BGAS	N/A	Moderate Contamination
	2632BD1X	3"	2-1/8"	0.13	1-1/8"	1/2"	(2) BGA	N/A	High Speed
	2632BD2X	3"	2-1/8"	0.13	1-1/8"	5/8"	(2) BGA	N/A	High Speed
	2632BD3X	3"	2-1/8"	0.13	1-1/8"	3/4"	(2) BGA	N/A	High Speed

	PART NUMBER	WHEEL		STANDOFF LENGTH	STANDOFF DIAMETER	THROUGH HOLE	BEARING	AUXILIARY SEAL	APPLICATION	
		DIAMETER	WIDTH							
		A	B	C	D	E				
Carbon Steel Body 	26306B13	3"	6"	0.13	1-1/8"	3/4"	(2) BGAS	N/A	Moderate Contamination	
Carbon Steel Body 	R35BR/BRG	3-1/2"	2-3/8"	N/A	N/A	N/A	(2) BGAS	(2) NRT	High Contamination	
	R35BR-1	3-1/2"	2-3/8"	N/A	N/A	1" Shaft Mount	(2) BGF	N/A	Moderate Contamination	
	R35BRP2	3-1/2"	2-3/8"	0.06	2"	5/8"	(2) BGAS	(2) NRT	High Contamination	
	R35BRR1	3-1/2"	2-3/8"	0.06	2"	1/2"	(2) BGAS	(2) NRT	High Contamination	
	R35BRR2	3-1/2"	2-3/8"	0.06	2"	5/8"	(2) BGAS	(2) NRT	High Contamination	
	R35BRR3	3-1/2"	2-3/8"	0.06	2"	3/4"	(2) BGAS	(2) NRT	High Contamination	
	R35BRU1	3-1/2"	2-3/8"	0.06	1-3/8"	1/2"	(2) BGAS	(2) NRT	High Contamination	
	R35BRU2	3-1/2"	2-3/8"	0.06	1-3/8"	5/8"	(2) BGAS	(2) NRT	High Contamination	
	R35BRU2	3-1/2"	2-3/8"	0.06	1-3/8"	3/4"	(2) BGAS	(2) NRT	High Contamination	
Carbon Steel Body 	R35BRLABG2	3-1/2"	4-1/8"	0.116	1-1/8"	5/8"	(2) BGAS	----	Moderate Contamination	
	R35BRLABG3	3-1/2"	4-1/8"	0.116	1-1/8"	3/4"	(2) BGAS	----	Moderate Contamination	
Carbon Steel Body 	R11A-1	4"	1"	N/A	N/A	1" Shaft Mount	(1) BGF	N/A	Moderate Contamination	
	R11A/BRG	4"	1"	N/A	N/A	N/A	(1) BGAS	N/A	Moderate Contamination	
	R11AB1	4"	1"	0.10	1-1/8"	1/2"	(1) BGAS	N/A	Moderate Contamination	
	R11AB2	4"	1"	0.10	1-1/8"	5/8"	(1) BGAS	N/A	Moderate Contamination	
	R11AB3	4"	1"	0.10	1-1/8"	3/4"	(1) BGAS	N/A	Moderate Contamination	
	R11AD1	4"	1"	3.03	1-1/2"	1/2"	(1) BGAS	N/A	Moderate Contamination	
	R11AD2	4"	1"	3.03	1-1/2"	5/8"	(1) BGAS	N/A	Moderate Contamination	
	R11AJ2	4"	1"	0.45	1-3/8"	5/8"	(1) BGAS	N/A	Moderate Contamination	
	R11AL1	4"	1"	1.08	1-1/2"	1/2"	(1) BGAS	N/A	Moderate Contamination	
	R11AL2	4"	1"	1.08	1-1/2"	5/8"	(1) BGAS	N/A	Moderate Contamination	
	R11AN1	4"	1"	1.64	1-1/2"	1/2"	(1) BGAS	N/A	Moderate Contamination	
	R11AN2	4"	1"	1.64	1-1/2"	5/8"	(1) BGAS	N/A	Moderate Contamination	
	R11AO1	4"	1"	1.33	1-1/2"	1/2"	(1) BGAS	N/A	Moderate Contamination	
	R11AO2	4"	1"	1.33	1-1/2"	5/8"	(1) BGAS	N/A	Moderate Contamination	
	R11AQ2	4"	1"	1.33	1-3/8"	5/8"	(1) BGAS	N/A	Moderate Contamination	
	R11AW1	4"	1"	0.17	1-3/8"	1/2"	(1) BGAS	N/A	Moderate Contamination	
	R11AW2	4"	1"	0.17	1-3/8"	5/8"	(1) BGAS	N/A	Moderate Contamination	
R11AY1	4"	1"	2.03	1-1/2"	1/2"	(1) BGAS	N/A	Moderate Contamination		
R11AY2	4"	1"	2.03	1-1/2"	5/8"	(1) BGAS	N/A	Moderate Contamination		
Carbon Steel Body 	R41NB2	4"	1"	1.707	1-1/8"	5/8"	(2) BGAS	(2) NRT	High Contamination	
	R41NB3	4"	1"	1.707	1-1/8"	3/4"	(2) BGAS	(2) NRT	High Contamination	
	R41NR2	4"	1"	1.957	2"	5/8"	(2) BGAS	(2) NRT	High Contamination	
	R41NSDBB2	4"	1"	3.019	2"	5/8"	(2) BGAS	(2) NRT	High Contamination	
	R41NSDBB3	4"	1"	3.019	2"	3/4"	(2) BGAS	(2) NRT	High Contamination	
Carbon Steel Body 	R18N-1	4"	1-1/4"	N/A	N/A	1" Shaft Mount	(1) BGF	N/A	Moderate Contamination	
	R18N/BRG	4"	1-1/4"	N/A	N/A	N/A	(1) BGAS	(2) NRT	High Contamination	
	R18NB1	4"	1-1/4"	-0.019	1-1/8"	1/2"	(1) BGAS	(2) NRT	High Contamination	
	R18NB2	4"	1-1/4"	-0.019	1-1/8"	5/8"	(1) BGAS	(2) NRT	High Contamination	
	R18NN1	4"	1-1/4"	1.525	1-1/2"	1/2"	(1) BGAS	(2) NRT	High Contamination	
	R18NO1	4"	1-1/4"	1.213	1-1/2"	1/2"	(1) BGAS	(2) NRT	High Contamination	
	R18NW2	4"	1-1/4"	0.051	1-3/8"	5/8"	(1) BGAS	(2) NRT	High Contamination	
	R18NX1	4"	1-1/4"	1.841	2"	1/2"	(1) BGAS	(2) NRT	High Contamination	
R18NX2	4"	1-1/4"	1.841	2"	5/8"	(1) BGAS	(2) NRT	High Contamination		

	PART NUMBER	WHEEL DIAMETER	WHEEL WIDTH	STANDOFF LENGTH	STANDOFF DIAMETER	THROUGH HOLE	BEARING	AUXILIARY SEAL	APPLICATION
		A	B	C	D	E			
 Carbon Steel Body	R40BR/BRG	4"	2-3/8"	----	----	----	(2) BGAS	(2) NRT	High Contamination
	R40BR-1	4"	2-3/8"	----	----	1" Shaft Mount	(2) BGF	----	Moderate Contamination
	R40BRP2	4"	2-3/8"	0.06	2"	5/8"	(2) BGAS	(2) NRT	High Contamination
	R40BRR1	4"	2-3/8"	0.06	2"	1/2"	(2) BGAS	(2) NRT	High Contamination
	R40BRR2	4"	2-3/8"	0.06	2"	5/8"	(2) BGAS	(2) NRT	High Contamination
	R40BRR3	4"	2-3/8"	0.06	2"	3/4"	(2) BGAS	(2) NRT	High Contamination
	R40BRU1	4"	2-3/8"	0.06	1-3/8"	1/2"	(2) BGAS	(2) NRT	High Contamination
	R40BRU2	4"	2-3/8"	0.06	1-3/8"	5/8"	(2) BGAS	(2) NRT	High Contamination
	R40BRU3	4"	2-3/8"	0.06	1-3/8"	3/4"	(2) BGAS	(2) NRT	High Contamination
 Carbon Steel Body	R45BR/BRG	4-1/2"	2-3/8"	----	----	----	(2) BGAS	(2) NRT	High Contamination
	R45BR-1	4-1/2"	2-3/8"	----	----	1" Shaft Mount	(2) BGF	----	Moderate Contamination
	R45BRP2	4-1/2"	2-3/8"	0.06	2"	5/8"	(2) BGAS	(2) NRT	High Contamination
	R45BRR1	4-1/2"	2-3/8"	0.06	2"	1/2"	(2) BGAS	(2) NRT	High Contamination
	R45BRR2	4-1/2"	2-3/8"	0.06	2"	5/8"	(2) BGAS	(2) NRT	High Contamination
	R45BRR3	4-1/2"	2-3/8"	0.06	2"	3/4"	(2) BGAS	(2) NRT	High Contamination
	R45BRU1	4-1/2"	2-3/8"	0.06	1-3/8"	1/2"	(2) BGAS	(2) NRT	High Contamination
	R45BRU2	4-1/2"	2-3/8"	0.06	1-3/8"	5/8"	(2) BGAS	(2) NRT	High Contamination
	R45BRU3	4-1/2"	2-3/8"	0.06	1-3/8"	3/4"	(2) BGAS	(2) NRT	High Contamination
 Carbon Steel Body	R12A-1	4-3/4"	1"	N/A	N/A	1" Shaft Mount	(1) BGF	N/A	Moderate Contamination
	R12A/BRG	4-3/4"	1"	N/A	N/A	N/A	(1) BGAS	N/A	Moderate Contamination
	R12AB2	4-3/4"	1"	0.1	1-1/8"	5/8"	(1) BGAS	N/A	Moderate Contamination
	R12AD2	4-3/4"	1"	3.03	1-1/2"	5/8"	(1) BGAS	N/A	Moderate Contamination
	R12AJ2	4-3/4"	1"	0.45	1-3/8"	5/8"	(1) BGAS	N/A	Moderate Contamination
	R12AL2	4-3/4"	1"	1.078	1-1/2"	5/8"	(1) BGAS	N/A	Moderate Contamination
	R12AO1	4-3/4"	1"	1.332	1-1/2"	1/2"	(1) BGAS	N/A	Moderate Contamination
	R12AW1	4-3/4"	1"	0.17	1-3/8"	1/2"	(1) BGAS	N/A	Moderate Contamination
	R12AW2	4-3/4"	1"	0.17	1-3/8"	5/8"	(1) BGAS	N/A	Moderate Contamination
	R12AY1	4-3/4"	1"	2.03	1-1/2"	1/2"	(1) BGAS	N/A	Moderate Contamination
	R12AY2	4-3/4"	1"	2.03	1-1/2"	5/8"	(1) BGAS	N/A	Moderate Contamination
	R12AY3	4-3/4"	1"	2.03	1-1/2"	3/4"	(1) BGAS	N/A	Moderate Contamination
 Carbon Steel Body	R51N/BRG	5"	1"	N/A	N/A	N/A	(2) BGAS	(2) NRT	High Contamination
	R51NR2	5"	1"	1.957	2"	5/8"	(2) BGAS	(2) NRT	High Contamination
	R51NSDBB2	5"	1"	3.019	2"	5/8"	(2) BGAS	(2) NRT	High Contamination
	R51NSDBB3	5"	1"	3.019	2"	3/4"	(2) BGAS	(2) NRT	High Contamination

BEARING INFORMATION

BGA - A 52MM (6205) Bearing used in high speed applications

BGAS - A 52MM (6205) Bearing used in low to moderate speed applications where high contamination is present

BGF - A 52MM Collar locking bearing used in low to moderate speed applications where moderate contamination is present (used only for 1" shaft mounts)





BGBS - A 40MM (6203) Bearing used in low to moderate speed applications where high contamination is present

BGB - A 40MM (6203) Bearing used in high speed applications

NB21 - A fixed bearing used in underwater applications

AUXILIARY SEAL INFORMATION

NRT - An auxiliary bearing seal that provides excellent protection in high contamination areas to greatly improve bearing life. The NRT seal has a low friction coefficient, providing low bearing drag.

	PART NUMBER	WHEEL DIAMETER	WHEEL WIDTH	STANDOFF LENGTH	STANDOFF DIAMETER	THROUGH HOLE	BEARING	AUXILIARY SEAL	APPLICATION
		A	B	C	D	E			
Carbon Steel Body 	R50BR/BRG	5"	2-3/8"	----	----	----	(2) BGAS	(2) NRT	High Contamination
	R50BR-1	5"	2-3/8"	----	----	1" Shaft Mount	(2) BGF	----	Moderate Contamination
	R50BRP2	5"	2-3/8"	0.06	2"	5/8"	(2) BGAS	(2) NRT	High Contamination
	R50BRR1	5"	2-3/8"	0.06	2"	1/2"	(2) BGAS	(2) NRT	High Contamination
	R50BRR2	5"	2-3/8"	0.06	2"	5/8"	(2) BGAS	(2) NRT	High Contamination
	R50BRR3	5"	2-3/8"	0.06	2"	3/4"	(2) BGAS	(2) NRT	High Contamination
	R50BRU1	5"	2-3/8"	0.06	1-3/8"	1/2"	(2) BGAS	(2) NRT	High Contamination
	R50BRU2	5"	2-3/8"	0.06	1-3/8"	5/8"	(2) BGAS	(2) NRT	High Contamination
	R50BRU3	5"	2-3/8"	0.06	1-3/8"	3/4"	(2) BGAS	(2) NRT	High Contamination
Carbon Steel Body 	R60A/BRG	6"	1"	N/A	N/A	N/A	(1) BGAS	N/A	Moderate Contamination
	R60AAGB2	6"	1"	3.33	3"	5/8"	(1) BGAS	N/A	Moderate Contamination
	R60AB1	6"	1"	0.1	1-1/8"	1/2"	(1) BGAS	N/A	Moderate Contamination
	R60AB2	6"	1"	0.1	1-1/8"	5/8"	(1) BGAS	N/A	Moderate Contamination
	R60AD2	6"	1"	3.03	1-1/2"	5/8"	(1) BGAS	N/A	Moderate Contamination
	R60AJ1	6"	1"	0.45	1-3/8"	1/2"	(1) BGAS	N/A	Moderate Contamination
	R60AJ2	6"	1"	0.45	1-3/8"	5/8"	(1) BGAS	N/A	Moderate Contamination
	R60AW1	6"	1"	0.17	1-3/8"	1/2"	(1) BGAS	N/A	Moderate Contamination
	R60AW2	6"	1"	0.17	1-3/8"	5/8"	(1) BGAS	N/A	Moderate Contamination
	R60AX1	6"	1"	1.96	2"	1/2"	(1) BGAS	N/A	Moderate Contamination
	R60AX2	6"	1"	1.96	2"	5/8"	(1) BGAS	N/A	Moderate Contamination
	R60AY1	6"	1"	2.03	1-1/2"	1/2"	(1) BGAS	N/A	Moderate Contamination
	R60AY2	6"	1"	2.03	1-1/2"	5/8"	(1) BGAS	N/A	Moderate Contamination
	Hardened Steel Body 	R61N/BRG	6"	1"	N/A	N/A	N/A	(2) BGAS	(2) NRT
R61NNB21		6"	1"	1.957	1-1/2"	5/8"	NB21	N/A	Under Water
R61NR2		6"	1"	1.957	2"	5/8"	(2) BGAS	(2) NRT	High Contamination
R61NR3		6"	1"	1.957	2"	3/4"	(2) BGAS	(2) NRT	High Contamination
R61NSDBB2		6"	1"	3.019	2"	5/8"	(2) BGAS	(2) NRT	High Contamination
R61NSDBB3		6"	1"	3.019	2"	3/4"	(2) BGAS	(2) NRT	High Contamination
Carbon Steel Body 	R90GGB2	9"	1-1/2"	2.678	2"	5/8"	(2) BGAS	(2) NRR	High Contamination

BEARING INFORMATION

BGA - A 52MM (6205) Bearing used in high speed applications

BGAS - A 52MM (6205) Bearing used in low to moderate speed applications where high contamination is present

BGF - A 52MM Collar locking bearing used in low to moderate speed applications where moderate contamination is present (used only for 1" shaft mounts)

BGBS - A 40MM (6203) Bearing used in low to moderate speed applications where high contamination is present

BGB - A 40MM (6203) Bearing used in high speed applications

NB21 - A fixed bearing used in underwater applications

AUXILIARY SEAL INFORMATION

NRT - An auxiliary bearing seal that provides excellent protection in high contamination areas to greatly improve bearing life. The NRT seal has a low friction coefficient, providing low bearing drag.



FLAT SERIES - RUBBER

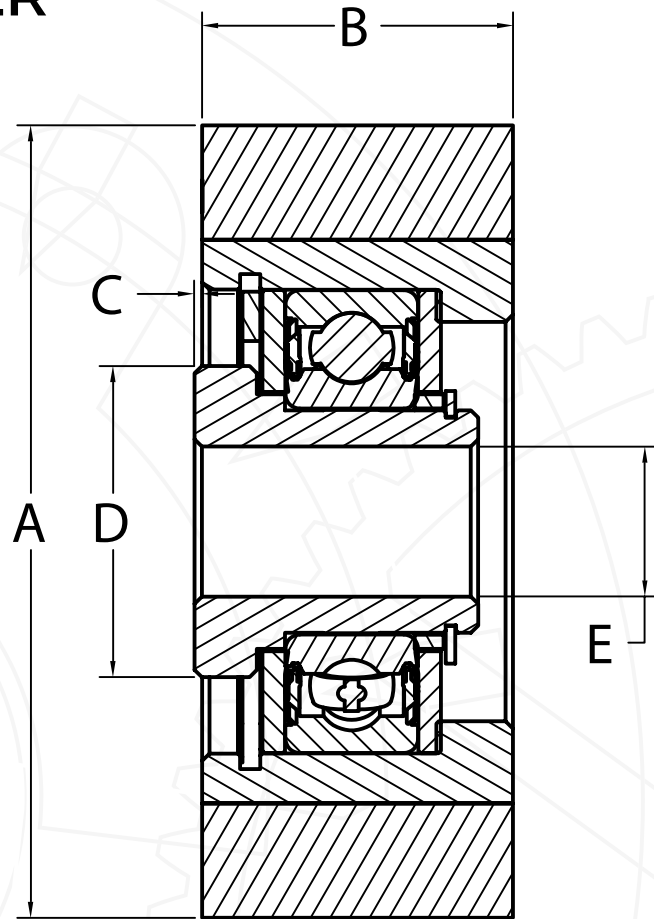

- A: Wheel Diameter
- B: Wheel Width
- C: Standoff Length
- D: Standoff Diameter
- E: Through Hole

BEARING INFORMATION

BGA - A 52MM (6205) Bearing used in high speed applications

BGAS - A 52MM (6205) Bearing used in low to moderate speed applications where high contamination is present

BGF - A 52MM Collar locking bearing used in low to moderate speed applications where moderate contamination is present (used only for 1" shaft mounts)

BGBS - A 40MM (6203) Bearing used in low to moderate speed applications where high contamination is present





BGB - A 40MM (6203) Bearing used in high speed applications

NB21 - A fixed bearing used in underwater applications

AUXILIARY SEAL INFORMATION

NRT - An auxiliary bearing seal that provides excellent protection in high contamination areas to greatly improve bearing life. The NRT seal has a low friction coefficient, providing low bearing drag.

	PART NUMBER	WHEEL DIAMETER	WHEEL WIDTH	STANDOFF LENGTH	STANDOFF DIAMETER	THROUGH HOLE	BEARING	AUXILIARY SEAL	APPLICATION
		A	B	C	D	E			
	2075CA	2"	3/4"	0.05	5/8"	5/16"	(1) BGT	----	High Speed
	2555CD1	2-1/4"	2-1/2"	0.25	1"	1/2"	(2) BGB	----	High Speed
	2755CB2	2-3/4"	1"	-0.13	EXTENDED RACE	3/8", 1/2", 5/8"	(1) BGBH	----	High Speed
	27132CB2	2-3/4"	1-3/8"	0.87	15/16"	5/8"	(2) BGBS	----	High Speed
	2713CB2	2-3/4"	1-3/8"	-0.302	EXTENDED RACE	5/8"	(1) BGBH	----	High Speed
	2550BE3	3-1/2"	1-3/8"	.16 OR .09	1-1/8"	1/2", 5/8", 3/4"	(1) BGA	----	High Speed
	RSBRR/BRG	3-1/2"	1-3/8"	----	----	----	(1) BGAS	(2) NRT	High Contamination
	RSBRRL1	3-1/2"	1-3/8"	0.958	1-1/2"	1/2"	(1) BGAS	(2) NRT	High Contamination
	RSBRRL2	3-1/2"	1-3/8"	0.958	1-1/2"	5/8"	(1) BGAS	(2) NRT	High Contamination
	RSBRRW1	3-1/2"	1-3/8"	0.05	1-3/8"	1/2"	(1) BGAS	(2) NRT	High Contamination
	RSBRRW2	3-1/2"	1-3/8"	0.05	1-3/8"	5/8"	(1) BGAS	(2) NRT	High Contamination
	RSBRRW3	3-1/2"	1-3/8"	0.05	1-3/8"	3/4"	(1) BGAS	(2) NRT	High Contamination
	RSBRRX1	3-1/2"	1-3/8"	1.84	2"	1/2"	(1) BGAS	(2) NRT	High Contamination
	RSBRRX2	3-1/2"	1-3/8"	1.84	2"	5/8"	(1) BGAS	(2) NRT	High Contamination
	RSBRRY2	3-1/2"	1-3/8"	1.91	1-1/2"	5/8"	(1) BGAS	(2) NRT	High Contamination
	RBRR/BRG	3-1/2"	2-1/8"	----	----	----	(2) BGAS	(2) NRT	High Contamination
	RBRR-1	3-1/2"	2-1/8"	----	----	1" Shaft Mount	(2) BGF	----	Moderate Contamination
	RBRRB2	3-1/2"	2-1/8"	0.06	1-1/8"	5/8"	(2) BGAS	(2) NRT	High Contamination
	RBRRP2	3-1/2"	2-1/8"	0.31	2"	5/8"	(2) BGAS	(2) NRT	High Contamination
	RBRRR2	3-1/2"	2-1/8"	0.31	2"	5/8"	(2) BGAS	(2) NRT	High Contamination
	RBRRU1	3-1/2"	2-1/8"	0.31	1-3/8"	1/2"	(2) BGAS	(2) NRT	High Contamination
	RBRRU2	3-1/2"	2-1/8"	0.31	1-3/8"	5/8"	(2) BGAS	(2) NRT	High Contamination
	2500BD3	3-1/2"	2-1/8"	0.12	1-1/8"	1/2", 5/8", 3/4"	(2) BGA	----	High Speed
	RBRRLABG2	3-1/2"	4-1/8"	0.116	1-1/8"	5/8"	(2) BGAS	----	Moderate Contamination
	RBRRLABG3	3-1/2"	4-1/8"	0.116	1-1/8"	3/4"	(2) BGAS	----	Moderate Contamination
	RBRRLABG3/BGA	3-1/2"	4-1/8"	0.116	1-1/8"	3/4"	(2) BGA	----	High Speed

	PART NUMBER	WHEEL DIAMETER	WHEEL WIDTH	STANDOFF LENGTH	STANDOFF DIAMETER	THROUGH HOLE	BEARING	AUXILIARY SEAL	APPLICATION	
		A	B	C	D	E				
	R40BRRBD2	4"	2-1/8"	0.328	1-1/8"	5/8"	(2) BGAS	(2) NRT	High Contamination	
	R40BRRM1	4"	2-1/8"	1.22	2"	1/2"	(2) BGAS	(2) NRT	High Contamination	
	R40BRRNB21	4"	2-1/8"	0.31	1-1/2"	5/8"	(1) NB21	----	Under Water	
	R40BRRP2	4"	2-1/8"	0.31	2"	5/8"	(2) BGAS	(2) NRT	High Contamination	
	R40BRRR2	4"	2-1/8"	0.31	2"	5/8"	(2) BGAS	(2) NRT	High Contamination	
	R40BRRU1	4"	2-1/8"	0.31	1-3/8"	1/2"	(2) BGAS	(2) NRT	High Contamination	
	R40BRRU2	4"	2-1/8"	0.31	1-3/8"	5/8"	(2) BGAS	(2) NRT	High Contamination	
	R40BRRU3	4"	2-1/8"	0.31	1-3/8"	3/4"	(2) BGAS	(2) NRT	High Contamination	
	R45BRR/BRG	4-1/2"	2-1/8"	----	----	----	(2) BGAS	(2) NRT	High Contamination	
	R45BRRR2	4-1/2"	2-1/8"	0.31	2"	5/8"	(2) BGAS	(2) NRT	High Contamination	
	R45BRRR3	4-1/2"	2-1/8"	0.31	2"	3/4"	(2) BGAS	(2) NRT	High Contamination	
	R45BRRU2	4-1/2"	2-1/8"	0.31	1-3/8"	5/8"	(2) BGAS	(2) NRT	High Contamination	
	R45BRRU3	4-1/2"	2-1/8"	0.31	1-3/8"	3/4"	(2) BGAS	(2) NRT	High Contamination	
	R45BRRUA35	4-1/2"	2-1/8"	1.47	1-3/8"	3/4"	(2) BGAS	(2) NRT	High Contamination	
	R5RR/BRG	5"	1-1/2"	----	----	----	(1) BGAS	(2) NRT	High Contamination	
	R5RR-1	5"	1-1/2"	----	----	1" Shaft Mount	(1) BGF	----	Moderate Contamination	
	R5RRAGB2	5"	1-1/2"	3.107	3"	5/8"	(1) BGAS	(2) NRT	High Contamination	
	R5RRB1	5"	1-1/2"	-0.123	1-1/8"	1/2"	(1) BGAS	(2) NRT	High Contamination	
	R5RRB2	5"	1-1/2"	-0.123	1-1/8"	5/8"	(1) BGAS	(2) NRT	High Contamination	
	R5RRB3	5"	1-1/2"	-0.123	1-1/8"	3/4"	(1) BGAS	(2) NRT	High Contamination	
	R5RRD2	5"	1-1/2"	2.807	1-1/2"	5/8"	(1) BGAS	(2) NRT	High Contamination	
	R5RRI2	5"	1-1/2"	2.127	1-1/8"	5/8"	(1) BGAS	(2) NRT	High Contamination	
	R5RRI3	5"	1-1/2"	2.127	1-1/8"	3/4"	(1) BGAS	(2) NRT	High Contamination	
	R5RRJ2	5"	1-1/2"	0.227	1-3/8"	5/8"	(1) BGAS	(2) NRT	High Contamination	
	R5RRL2	5"	1-1/2"	0.855	1-1/2"	5/8"	(1) BGAS	(2) NRT	High Contamination	
	R5RRL3	5"	1-1/2"	0.855	1-1/2"	3/4"	(1) BGAS	(2) NRT	High Contamination	
	R5RRO2	5"	1-1/2"	1.109	1-1/2"	5/8"	(1) BGAS	(2) NRT	High Contamination	
	R5RRQ2	5"	1-1/2"	-0.153	1-3/8"	5/8"	(1) BGAS	(2) NRT	High Contamination	
	R5RRQ3	5"	1-1/2"	-0.153	1-3/8"	3/4"	(1) BGAS	(2) NRT	High Contamination	
	R5RRW2	5"	1-1/2"	-0.053	1-3/8"	5/8"	(1) BGAS	(2) NRT	High Contamination	
	R5RRY1	5"	1-1/2"	1.807	1-1/2"	1/2"	(1) BGAS	(2) NRT	High Contamination	
	R5RRY2	5"	1-1/2"	1.807	1-1/2"	5/8"	(1) BGAS	(2) NRT	High Contamination	
		R6RR/BRG	6"	1-1/2"	----	----	----	(1) BGAS	(2) NRT	High Contamination
		R6RRB1	6"	1-1/2"	-0.123	1-1/8"	1/2"	(1) BGAS	(2) NRT	High Contamination
R6RRB2		6"	1-1/2"	-0.123	1-1/8"	5/8"	(1) BGAS	(2) NRT	High Contamination	
R6RRD2		6"	1-1/2"	2.807	1-1/2"	5/8"	(1) BGAS	(2) NRT	High Contamination	
R6RRI1		6"	1-1/2"	2.127	1-1/8"	1/2"	(1) BGAS	(2) NRT	High Contamination	
R6RRI2		6"	1-1/2"	2.127	1-1/8"	5/8"	(1) BGAS	(2) NRT	High Contamination	
R6RRJ2		6"	1-1/2"	0.227	1-3/8"	5/8"	(1) BGAS	(2) NRT	High Contamination	
R6RRL2		6"	1-1/2"	0.855	1-1/2"	5/8"	(1) BGAS	(2) NRT	High Contamination	
R6RRO1		6"	1-1/2"	1.109	1-1/2"	1/2"	(1) BGAS	(2) NRT	High Contamination	
R6RRO2		6"	1-1/2"	1.109	1-1/2"	5/8"	(1) BGAS	(2) NRT	High Contamination	
R6RRQ2		6"	1-1/2"	-0.153	1-3/8"	5/8"	(1) BGAS	(2) NRT	High Contamination	
R6RRW2		6"	1-1/2"	-0.053	1-3/8"	5/8"	(1) BGAS	(2) NRT	High Contamination	
R6RRY2		6"	1-1/2"	1.807	1-1/2"	5/8"	(1) BGAS	(2) NRT	High Contamination	
		R6517RAHH2	6-9/16"	1-7/8"	3.282	3"	5/8"	(2) BGAS	(2) NRT	High Contamination

	PART NUMBER	WHEEL DIAMETER	WHEEL WIDTH	STANDOFF LENGTH	STANDOFF DIAMETER	THROUGH HOLE	BEARING	AUXILIARY SEAL	APPLICATION
		A	B	C	D	E			
 Steel/Rubber Body	R652RA-1	6-9/16"	2-1/4"	----	----	1" SHAFT MOUNT	(2) BGF	----	Moderate Contamination
	R652RAH2	6-9/16"	2-1/4"	2.967	3"	5/8"	(2) BGAS	(2) NRT	High Contamination
	R652RAR2	6-9/16"	2-1/4"	0.352	2"	5/8"	(2) BGAS	----	Moderate Contamination
	R652RR1	6-9/16"	2-1/4"	0.352	2"	1/2"	(2) BGAS	(2) NRT	High Contamination
	R652RR2	6-9/16"	2-1/4"	0.352	2"	5/8"	(2) BGAS	(2) NRT	High Contamination
	R652RR3	6-9/16"	2-1/4"	0.352	2"	3/4"	(2) BGAS	(2) NRT	High Contamination
 Cast/Rubber Body	2973/BRG	7-3/16"	1-1/2"	----	----	----	(1) BGAS	(2) NRT	High Contamination
	2973B2	7-3/16"	1-1/2"	-0.16	1-1/8"	5/8"	(1) BGAS	(2) NRT	High Contamination
	2973B3	7-3/16"	1-1/2"	-0.16	1-1/8"	3/4"	(1) BGAS	(2) NRT	High Contamination
	2973BE3	7-3/16"	1-1/2"	0.035	1-1/8"	3/4"	(1) BGAS	(2) NRT	High Contamination
	2973L2	7-3/16"	1-1/2"	0.825	1-1/2"	5/8"	(1) BGAS	(2) NRT	High Contamination
	2973Y2	7-3/16"	1-1/2"	1.777	1-1/2"	5/8"	(1) BGAS	(2) NRT	High Contamination

NOTES | DRAWINGS

BEARING INFORMATION

BGA - A 52MM (6205) Bearing used in high speed applications

BGAS - A 52MM (6205) Bearing used in low to moderate speed applications where high contamination is present

BGF - A 52MM Collar locking bearing used in low to moderate speed applications where moderate contamination is present (used only for 1" shaft mounts)

BGBS - A 40MM (6203) Bearing used in low to moderate speed applications where high contamination is present

BGB - A 40MM (6203) Bearing used in high speed applications

NB21 - A fixed bearing used in underwater applications

AUXILIARY SEAL INFORMATION

NRT - An auxiliary bearing seal that provides excellent protection in high contamination areas to greatly improve bearing life. The NRT seal has a low friction coefficient, providing low bearing drag.

URETHANE ROLLERS

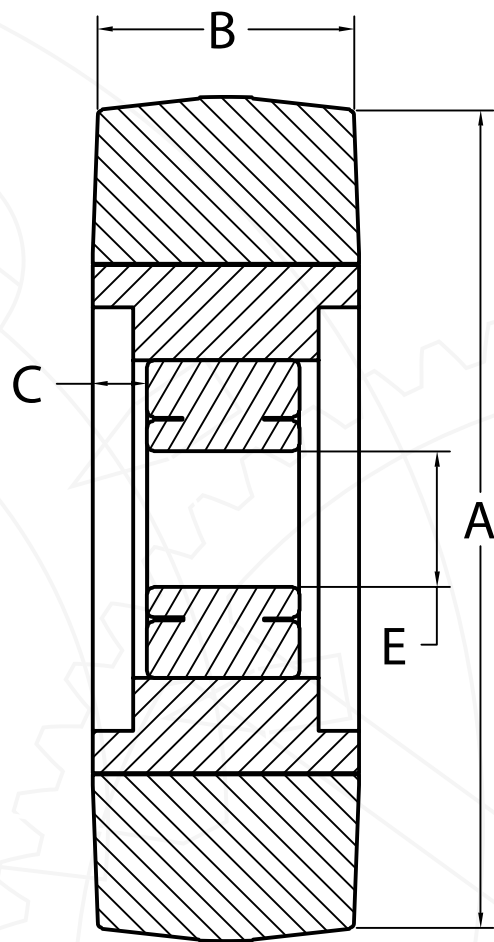

- A: Wheel Diameter
- B: Wheel Width
- C: Standoff Length
- D: Standoff Diameter
- E: Through Hole

BEARING INFORMATION

BGA - A 52MM (6205) Bearing used in high speed applications

BGAS - A 52MM (6205) Bearing used in low to moderate speed applications where high contamination is present

BGF - A 52MM Collar locking bearing used in low to moderate speed applications where moderate contamination is present (used only for 1" shaft mounts)



BGBS - A 40MM (6203) Bearing used in low to moderate speed applications where high contamination is present

BGB - A 40MM (6203) Bearing used in high speed applications

NB21 - A fixed bearing used in underwater applications

AUXILIARY SEAL INFORMATION

NRT - An auxiliary bearing seal that provides excellent protection in high contamination areas to greatly improve bearing life. The NRT seal has a low friction coefficient, providing low bearing drag.

	PART NUMBER	WHEEL DIAMETER	WHEEL WIDTH	STANDOFF LENGTH	STANDOFF DIAMETER	THROUGH HOLE	BEARING	AUXILIARY SEAL	APPLICATION
		A	B	C	D	E			
 Urethane Body	2945G	4"	1-1/4"	-0.255	----	5/8"	N/A	----	Moderate Contamination
 Urethane Body	2955G	5"	1-1/4"	-0.255	----	5/8"	N/A	----	Moderate Contamination

NOTES | DRAWINGS

Blank area for notes and drawings.

TAPERED EDGE SERIES - STEEL

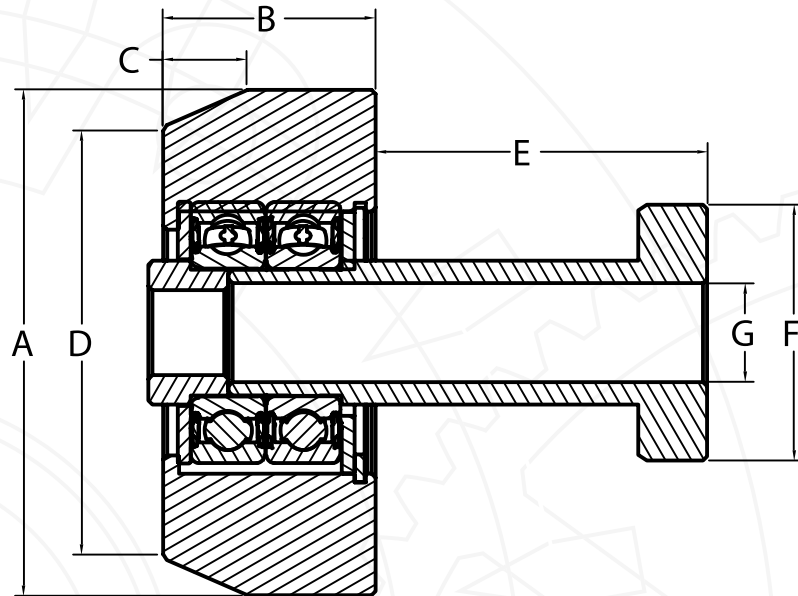

- A: Wheel Diameter
- B: Wheel Width
- C: Taper Length
- D: Taper Diameter
- E: Standoff Length
- F: Standoff Diameter
- G: Through Hole

BEARING INFORMATION

BGA - A 52MM (6205) Bearing used in high speed applications

BGAS - A 52MM (6205) Bearing used in low to moderate speed applications where high contamination is present

BGF - A 52MM Collar locking bearing used in low to moderate speed applications where moderate contamination is present (used only for 1" shaft mounts)

BGBS - A 40MM (6203) Bearing used in low to moderate speed applications where high contamination is present

BGB - A 40MM (6203) Bearing used in high speed applications

NB21 - A fixed bearing used in underwater applications

AUXILIARY SEAL INFORMATION

NRT - An auxiliary bearing seal that provides excellent protection in high contamination areas to greatly improve bearing life. The NRT seal has a low friction coefficient, providing low bearing drag.

	PART NUMBER	WHEEL	WHEEL	TAPER	TAPER	STANDOFF	STANDOFF	THROUGH	BEARING	AUXILIARY	APPLICATION
		DIAMETER	WIDTH	LENGTH	DIAMETER	LENGTH	DIAMETER	HOLE	H	SEAL	
		A	B	C	D	E	F	G	H		
 Hardened Steel Body	R27A/BRG	2-3/4"	1-1/2"	1/2"	2-1/8"	----	----	----	(2) BGAS	----	Moderate Contamination
	R27AAD2	2-3/4"	1-1/2"	1/2"	2-1/8"	3.1	1-1/2"	5/8"	(2) BGAS	----	Moderate Contamination
	R27AB1	2-3/4"	1-1/2"	1/2"	2-1/8"	0.16	1-1/8"	1/2"	(2) BGAS	----	Moderate Contamination
	R27AB2	2-3/4"	1-1/2"	1/2"	2-1/8"	0.16	1-1/8"	5/8"	(2) BGAS	----	Moderate Contamination
	R27ALLB1	2-3/4"	1-1/2"	1/2"	2-1/8"	0.83	1-1/2"	1/2"	(2) BGAS	----	Moderate Contamination
	R27AU2	2-3/4"	1-1/2"	1/2"	2-1/8"	0.41	1-3/8"	5/8"	(2) BGAS	----	Moderate Contamination
	R27AUA2	2-3/4"	1-1/2"	1/2"	2-1/8"	1.57	1-3/8"	5/8"	(2) BGAS	----	Moderate Contamination
 Carbon Steel Body	R37A/BRG	3-1/2"	1-1/2"	1/2"	2-7/8"	----	----	----	(2) BGAS	----	Moderate Contamination
	R37AAD2	3-1/2"	1-1/2"	1/2"	2-7/8"	3.1	1-1/2"	5/8"	(2) BGAS	----	Moderate Contamination
	R37AB2	3-1/2"	1-1/2"	1/2"	2-7/8"	0.16	1-1/8"	5/8"	(2) BGAS	----	Moderate Contamination
	R37ABD1	3-1/2"	1-1/2"	1/2"	2-7/8"	0.428	1-1/8"	1/2"	(2) BGAS	----	Moderate Contamination
	R37AU1	3-1/2"	1-1/2"	1/2"	2-7/8"	0.41	1-3/8"	1/2"	(2) BGAS	----	Moderate Contamination
	R37AU2	3-1/2"	1-1/2"	1/2"	2-7/8"	0.41	1-3/8"	5/8"	(2) BGAS	----	Moderate Contamination
	R37AUA1	3-1/2"	1-1/2"	1/2"	2-7/8"	1.57	1-3/8"	1/2"	(2) BGAS	----	Moderate Contamination
	R37AUAB1	3-1/2"	1-1/2"	1/2"	2-7/8"	1.57	1-1/2"	1/2"	(2) BGAS	----	Moderate Contamination
	R37AUAB2	3-1/2"	1-1/2"	1/2"	2-7/8"	1.57	1-1/2"	1/2"	(2) BGAS	----	Moderate Contamination
 Carbon Steel Body	R5BRS2	3-1/2"	3"	9/16"	2-1/2"	0.05	2"	5/8"	(2)BGAS	(1) NRT (1) DC150	High Contamination
 Hardened Steel Body	R39H/BRG	4"	1-5/8"	5/8"	3-3/8"	----	----	----	(2) BGAS	(2) NRT	High Contamination
	R39HADD2	4"	1-5/8"	5/8"	3-3/8"	2.942	2"	5/8"	(2) BGAS	(2) NRT	High Contamination
	R39HAUB2	4"	1-5/8"	5/8"	3-3/8"	1.487	1-1/2"	5/8"	(2) BGAS	(2) NRT	High Contamination
	R39HB2	4"	1-5/8"	5/8"	3-3/8"	0.077	1-1/8"	5/8"	(2) BGAS	(2) NRT	High Contamination
	R39HB3	4"	1-5/8"	5/8"	3-3/8"	0.077	1-1/8"	3/4"	(2) BGAS	(2) NRT	High Contamination
	R39HGGB2	4"	1-5/8"	5/8"	3-3/8"	2.6	2"	5/8"	(2) BGAS	(2) NRT	High Contamination
	R39HGGB3	4"	1-5/8"	5/8"	3-3/8"	2.6	2"	3/4"	(2) BGAS	(2) NRT	High Contamination
	R39HLLB2	4"	1-5/8"	5/8"	3-3/8"	0.747	1-1/2"	5/8"	(2) BGAS	(2) NRT	High Contamination
	R39HR3	4"	1-5/8"	5/8"	3-3/8"	0.327	2"	3/4"	(2) BGAS	(2) NRT	High Contamination
	R39HU2	4"	1-5/8"	5/8"	3-3/8"	0.327	1-3/8"	5/8"	(2) BGAS	(2) NRT	High Contamination
	R39HU3	4"	1-5/8"	5/8"	3-3/8"	0.327	1-3/8"	3/4"	(2) BGAS	(2) NRT	High Contamination
	R39HUAB2	4"	1-5/8"	5/8"	3-3/8"	1.487	1-1/2"	5/8"	(2) BGAS	(2) NRT	High Contamination

FLANGED SERIES - STEEL

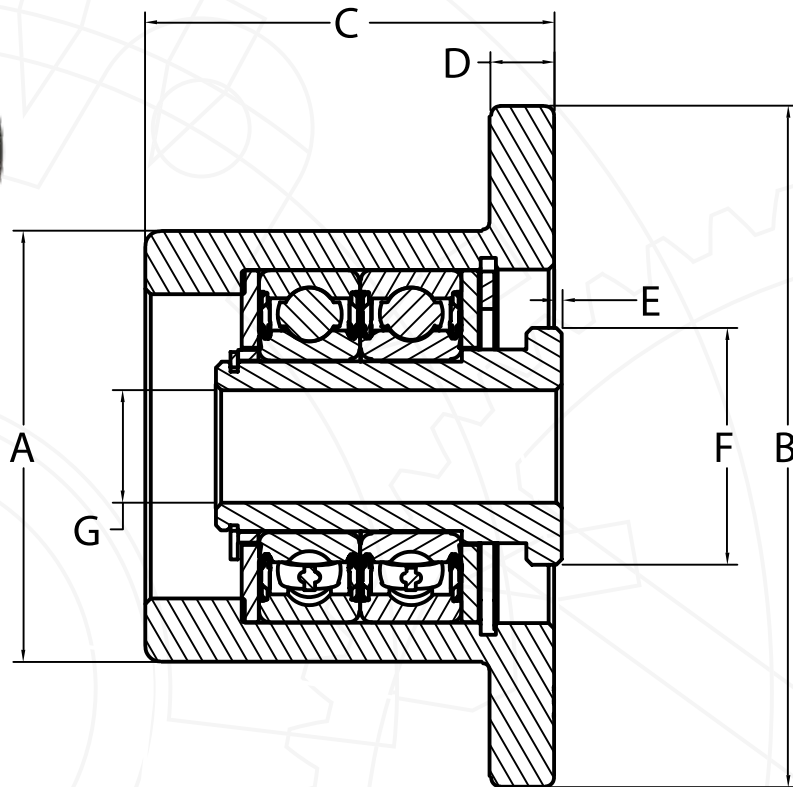

- A: Wheel Diameter
- B: Flange Diameter
- C: Total Width
- D: Flange Width
- E: Standoff Length
- F: Standoff Diameter
- G: Through Hole

BEARING INFORMATION

BGA - A 52MM (6205) Bearing used in high speed applications

BGAS - A 52MM (6205) Bearing used in low to moderate speed applications where high contamination is present

BGF - A 52MM Collar locking bearing used in low to moderate speed applications where moderate contamination is present (used only for 1" shaft mounts)

BGBS - A 40MM (6203) Bearing used in low to moderate speed applications where high contamination is present

BGB - A 40MM (6203) Bearing used in high speed applications

NB21 - A fixed bearing used in underwater applications

AUXILIARY SEAL INFORMATION

NRT - An auxiliary bearing seal that provides excellent protection in high contamination areas to greatly improve bearing life. The NRT seal has a low friction coefficient, providing low bearing drag.

	PART NUMBER	WHEEL DIAMETER	FLANGE DIAMETER	TOTAL WIDTH	FLANGE WIDTH	STANDOFF LENGTH	STANDOFF DIAMETER	THROUGH HOLE	BEARING	AUXILIARY SEAL	APPLICATION
		A	B	C	D	E	F	G	H		
	R4FBRSP2	2-1/2"	4"	2-3/8"	3/8"	0.06	2"	5/8"	(2) BGAS	(2) NRT	High Contamination
	R4FBRSU1	2-1/2"	4"	2-3/8"	3/8"	0.06	1-3/8"	1/2"	(2) BGAS	(2) NRT	High Contamination
	R4FBRSU2	2-1/2"	4"	2-3/8"	3/8"	0.06	1-3/8"	5/8"	(2) BGAS	(2) NRT	High Contamination
	R4FBRSLU1	2-1/2"	4"	4-3/8"	3/8"	0.06	1-3/8"	1/2"	(2) BGAS	(2) NRT	High Contamination
	R4FBRSLU2	2-1/2"	4"	4-3/8"	3/8"	0.06	1-3/8"	5/8"	(2) BGAS	(2) NRT	High Contamination
	R4FBRSLU3	2-1/2"	4"	4-3/8"	3/8"	0.06	1-3/8"	3/4"	(2) BGAS	(2) NRT	High Contamination
	R5F25BRSP2	2-1/2"	5"	2-3/8"	3/8"	0.06	2"	5/8"	(2) BGAS	(2) NRT	Scraper Option
	R5F25BRSU1	2-1/2"	5"	2-3/8"	3/8"	0.06	1-3/8"	1/2"	(2) BGAS	(2) NRT	High Contamination
	R5F25BRSU2	2-1/2"	5"	2-3/8"	3/8"	0.06	1-3/8"	5/8"	(2) BGAS	(2) NRT	High Contamination
	R6FBRSP2	3-1/2"	6"	2-3/8"	1/4"	0.06	2"	5/8"	(2) BGAS	(2) NRT	High Contamination
	R6FBRSR2	3-1/2"	6"	2-3/8"	1/4"	0.06	2"	5/8"	(2) BGAS	(2) NRT	High Contamination
	R6FBRSU2	3-1/2"	6"	2-3/8"	1/4"	0.06	1-3/8"	5/8"	(2) BGAS	(2) NRT	High Contamination
	R6FBRSU3	3-1/2"	6"	2-3/8"	1/4"	0.06	1-3/8"	3/4"	(2) BGAS	(2) NRT	High Contamination
	R5FBRSP2	3-1/2"	5"	2-3/8"	1/4"	0.06	2"	5/8"	(2) BGAS	(2) NRT	Scraper Option
	R5FBRSR2	3-1/2"	5"	2-3/8"	1/4"	0.06	2"	5/8"	(2) BGAS	(2) NRT	High Contamination
	R5FBRSU1	3-1/2"	5"	2-3/8"	1/4"	0.06	1-3/8"	1/2"	(2) BGAS	(2) NRT	High Contamination
	R5FBRSU2	3-1/2"	5"	2-3/8"	1/4"	0.06	1-3/8"	5/8"	(2) BGAS	(2) NRT	High Contamination
	R5FBRSU3	3-1/2"	5"	2-3/8"	1/4"	0.06	1-3/8"	3/4"	(2) BGAS	(2) NRT	High Contamination
	R5FBRSNB21	3-1/2"	5"	2-3/8"	1/4"	0.06	1-1/2"	5/8"	(1) NB21	----	Under Water
	R5FBR/BRG	3-1/2"	5"	2-3/8"	1/4"	----	----	----	(2) BGAS	(2) NRT	High Contamination
	R5SFBR/BRG	3-1/2"	5"	1-3/8"	1/4"	----	1-1/8"	----	(1) BGAS	(2) NRT	High Contamination
	R5SFBR-1	3-1/2"	5"	1-3/8"	1/4"	----	----	1" Shaft Mount	(1) BGF	----	Moderate Contamination
	R5SFBRW1	3-1/2"	5"	1-3/8"	1/4"	0.053	1-3/8"	1/2"	(1) BGAS	(2) NRT	High Contamination
	R5SFBRW2	3-1/2"	5"	1-3/8"	1/4"	0.053	1-3/8"	5/8"	(1) BGAS	(2) NRT	High Contamination
	R16L1	3-3/8"	4"	1-1/4"	1/4"	0.961	1-1/2"	1/2"	(1) BGAS	(2) NRT	High Contamination
	R16L2	3-3/8"	4"	1-1/4"	1/4"	0.961	1-1/2"	1/2"	(1) BGAS	(2) NRT	High Contamination
	R16W1	3-3/8"	4"	1-1/4"	1/4"	0.053	1-3/8"	1/2"	(1) BGAS	(2) NRT	High Contamination
	R16W2	3-3/8"	4"	1-1/4"	1/4"	0.053	1-3/8"	5/8"	(1) BGAS	(2) NRT	High Contamination
	R16W3	3-3/8"	4"	1-1/4"	1/4"	0.053	1-3/8"	3/4"	(1) BGAS	(2) NRT	High Contamination
	R16Y1	3-3/8"	4"	1-1/4"	1/4"	1.913	1-1/2"	1/2"	(1) BGAS	(2) NRT	High Contamination
	R16Y2	3-3/8"	4"	1-1/4"	1/4"	1.913	1-1/2"	5/8"	(1) BGAS	(2) NRT	High Contamination
	R16/BRG	3-3/8"	4"	1-1/4"	1/4"	----	----	----	(1) BGAS	(2) NRT	High Contamination

	PART NUMBER	WHEEL DIAMETER	FLANGE DIAMETER	TOTAL WIDTH	FLANGE WIDTH	STANDOFF LENGTH	STANDOFF DIAMETER	THROUGH HOLE	BEARING	AUXILIARY SEAL	APPLICATION
		A	B	C	D	E	F	G	H		
Hardened Steel Body 	R15HI1	3-3/8"	4-1/2"	1-1/4"	1/4"	0.961	1-1/8"	1/2"	(1) BGAS	(2) NRT	High Contamination
	R15HI2	3-3/8"	4-1/2"	1-1/4"	1/4"	0.961	1-1/8"	5/8"	(1) BGAS	(2) NRT	High Contamination
	R15HJ1	3-3/8"	4-1/2"	1-1/4"	1/4"	0.333	1-3/8"	1/2"	(1) BGAS	(2) NRT	High Contamination
	R15HJ2	3-3/8"	4-1/2"	1-1/4"	1/4"	0.333	1-3/8"	5/8"	(1) BGAS	(2) NRT	High Contamination
	R15HL1	3-3/8"	4-1/2"	1-1/4"	1/4"	0.961	1-1/2"	1/2"	(1) BGAS	(2) NRT	High Contamination
	R15HL2	3-3/8"	4-1/2"	1-1/4"	1/4"	0.961	1-1/2"	5/8"	(1) BGAS	(2) NRT	High Contamination
	R15HN1	3-3/8"	4-1/2"	1-1/4"	1/4"	1.527	1-1/2"	1/2"	(1) BGAS	(2) NRT	High Contamination
	R15HN2	3-3/8"	4-1/2"	1-1/4"	1/4"	1.527	1-1/2"	5/8"	(1) BGAS	(2) NRT	High Contamination
	R15HO1	3-3/8"	4-1/2"	1-1/4"	1/4"	1.215	1-1/2"	1/2"	(1) BGAS	(2) NRT	High Contamination
	R15HO2	3-3/8"	4-1/2"	1-1/4"	1/4"	1.215	1-1/2"	5/8"	(1) BGAS	(2) NRT	High Contamination
	R15HW1	3-3/8"	4-1/2"	1-1/4"	1/4"	0.053	1-3/8"	1/2"	(1) BGAS	(2) NRT	High Contamination
	R15HW2	3-3/8"	4-1/2"	1-1/4"	1/4"	0.053	1-3/8"	5/8"	(1) BGAS	(2) NRT	High Contamination
	R15HY1	3-3/8"	4-1/2"	1-1/4"	1/4"	1.913	1-1/2"	1/2"	(1) BGAS	(2) NRT	High Contamination
	R15HY2	3-3/8"	4-1/2"	1-1/4"	1/4"	1.913	1-1/2"	5/8"	(1) BGAS	(2) NRT	High Contamination
	R15HX1	3-3/8"	4-1/2"	1-1/4"	1/4"	1.843	2"	1/2"	(1) BGAS	(2) NRT	High Contamination
R15HX2	3-3/8"	4-1/2"	1-1/4"	1/4"	1.843	2"	5/8"	(1) BGAS	(2) NRT	High Contamination	
Carbon Steel Body 	R14A/BRG	4"	6-1/2"	1-5/16"	3/8"	----	----	----	(1)BGAS	----	Moderate Contamination
	R14AW1	4"	6-1/2"	1-5/16"	3/8"	0.053	1-3/8"	1/2"	(1)BGAS	----	Moderate Contamination
	R14AW2	4"	6-1/2"	1-5/16"	3/8"	0.053	1-3/8"	5/8"	(1)BGAS	----	Moderate Contamination
	R14AW3	4"	6-1/2"	1-5/16"	3/8"	0.053	1-3/8"	3/4"	(1)BGAS	----	Moderate Contamination
Hardened Steel Body 	R32NAHR2	4"	5"	2-1/4"	7/16"	0.06	2"	5/8"	(2) BGAS	(2) NRT	High Contamination
Carbon Steel Body 	R25DNP2	6-9/16"	9-1/2"	2-1/2"	5/16"	0.08	2"	5/8"	(2) BGAS	(2) NRT	Scrapper Option
	R25DNR1	6-9/16"	9-1/2"	2-1/2"	5/16"	0.08	2"	1/2"	(2) BGAS	(2) NRT	High Contamination
	R25DNR-1	6-9/16"	9-1/2"	2-1/2"	5/16"	----	----	1" Shaft Mount	(2) BGAS	(2) NRT	High Contamination
	R25DNR2	6-9/16"	9-1/2"	2-1/2"	5/16"	0.08	2"	5/8"	(2) BGAS	(2) NRT	High Contamination
	R25DNR3	6-9/16"	9-1/2"	2-1/2"	5/16"	0.08	2"	3/4"	(2) BGAS	(2) NRT	High Contamination



BEARING INFORMATION

BGA - A 52MM (6205) Bearing used in high speed applications

BGAS - A 52MM (6205) Bearing used in low to moderate speed applications where high contamination is present

BGF - A 52MM Collar locking bearing used in low to moderate speed applications where moderate contamination is present (used only for 1" shaft mounts)

BGBS - A 40MM (6203) Bearing used in low to moderate speed applications where high contamination is present

BGB - A 40MM (6203) Bearing used in high speed applications

NB21 - A fixed bearing used in underwater applications

AUXILIARY SEAL INFORMATION

NRT - An auxiliary bearing seal that provides excellent protection in high contamination areas to greatly improve bearing life. The NRT seal has a low friction coefficient, providing low bearing drag.

FLANGED SERIES - RUBBER

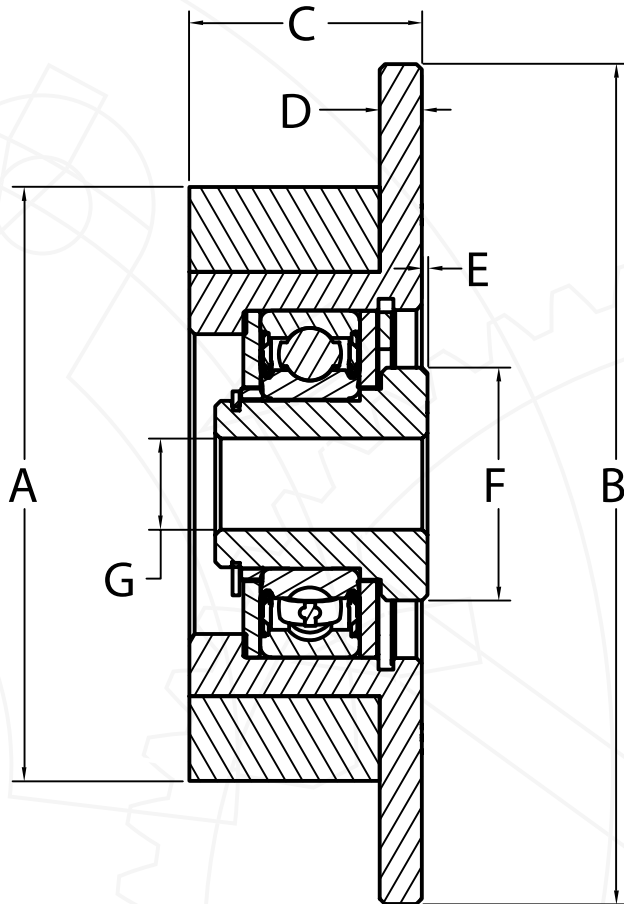

- A: Wheel Diameter
- B: Flange Diameter
- C: Total Width
- D: Flange Width
- E: Standoff Length
- F: Standoff Diameter
- G: Through Hole

BEARING INFORMATION

BGA - A 52MM (6205) Bearing used in high speed applications

BGAS - A 52MM (6205) Bearing used in low to moderate speed applications where high contamination is present

BGF - A 52MM Collar locking bearing used in low to moderate speed applications where moderate contamination is present (used only for 1" shaft mounts)

BGBS - A 40MM (6203) Bearing used in low to moderate speed applications where high contamination is present

BGB - A 40MM (6203) Bearing used in high speed applications

NB21 - A fixed bearing used in underwater applications

AUXILIARY SEAL INFORMATION

NRT - An auxiliary bearing seal that provides excellent protection in high contamination areas to greatly improve bearing life. The NRT seal has a low friction coefficient, providing low bearing drag.

	PART NUMBER	WHEEL DIAMETER	FLANGE DIAMETER	TOTAL WIDTH	FLANGE WIDTH	STANDOFF LENGTH	STANDOFF DIAMETER	THROUGH HOLE	BEARING	AUXILIARY SEAL	APPLICATION
		A	B	C	D	E	F	G	H		
	R5SFBRRC/BRG	3-1/2"	5"	1-3/8"	1/4"	----	----	----	(1) BGAS	(2) NRT	High Contamination
	R5SFBRRCNB11	3-1/2"	5"	1-3/8"	1/4"	0.232	1-1/2"	5/8"	(1) NB11	----	Under Water
	R5SFBRRCW1	3-1/2"	5"	1-3/8"	1/4"	0.052	1-3/8"	1/2"	(1) BGAS	(2) NRT	High Contamination
	R5SFBRRCW2	3-1/2"	5"	1-3/8"	1/4"	0.052	1-3/8"	5/8"	(1) BGAS	(2) NRT	High Contamination
	R5SFBRRCW3	3-1/2"	5"	1-3/8"	1/4"	0.052	1-3/8"	3/4"	(1) BGAS	(2) NRT	High Contamination
	R5FBRRC-1	3-1/2"	5"	2-3/8"	1/4"	----	----	1" Shaft Mount	(2) BGF	----	Moderate Contamination
	R5FBRRCNB21	3-1/2"	5"	2-3/8"	1/4"	0.062	1-1/2"	5/8"	(1) NB21	----	Under Water
	R5FBRRCP2	3-1/2"	5"	2-3/8"	1/4"	0.062	2"	5/8"	(2) BGAS	(2) NRT	High Contamination
	R5FBRRCU1	3-1/2"	5"	2-3/8"	1/4"	0.062	1-3/8"	1/2"	(2) BGAS	(2) NRT	High Contamination
	R5FBRRCU2	3-1/2"	5"	2-3/8"	1/4"	0.062	1-3/8"	5/8"	(2) BGAS	(2) NRT	High Contamination
	R5FBRRCU3	3-1/2"	5"	2-3/8"	1/4"	0.062	1-3/8"	3/4"	(2) BGAS	(2) NRT	High Contamination
	R6FBRR/BRG	3-1/2"	6-1/2"	2-3/8"	1/4"	----	----	----	(2) BGAS	(2) NRT	High Contamination
	R6FBRRNB21	3-1/2"	6-1/2"	2-3/8"	1/4"	0.062	1-1/2"	5/8"	(1) NB21	----	Under Water
	R6FBRRP2	3-1/2"	6-1/2"	2-3/8"	1/4"	0.062	2"	5/8"	(2) BGAS	(2) NRT	High Contamination
	R6FBRRU1	3-1/2"	6-1/2"	2-3/8"	1/4"	0.062	1-3/8"	1/2"	(2) BGAS	(2) NRT	High Contamination
	R6FBRRU2	3-1/2"	6-1/2"	2-3/8"	1/4"	0.062	1-3/8"	5/8"	(2) BGAS	(2) NRT	High Contamination
	R6FBRRU3	3-1/2"	6-1/2"	2-3/8"	1/4"	0.062	1-3/8"	3/4"	(2) BGAS	(2) NRT	High Contamination
	R6FBRRLU2	3-1/2"	6-1/2"	4-3/8"	1/4"	0.062	1-3/8"	5/8"	(2) BGAS	(2) NRT	High Contamination
	R8FBRR/BRG	3-1/2"	7-7/8"	2-3/8"	1/4"	----	----	----	(2) BGAS	(2) NRT	High Contamination
	R8FBRR2	3-1/2"	7-7/8"	2-3/8"	1/4"	0.062	1-3/8"	5/8"	(2) BGAS	(2) NRT	High Contamination
	R8FBRRP2	3-1/2"	7-7/8"	2-3/8"	1/4"	0.062	2"	5/8"	(2) BGAS	(2) NRT	High Contamination
	R8FBRRU1	3-1/2"	7-7/8"	2-3/8"	1/4"	0.062	1-3/8"	1/2"	(2) BGAS	(2) NRT	High Contamination
	R8FBRRU2	3-1/2"	7-7/8"	2-3/8"	1/4"	0.062	1-3/8"	5/8"	(2) BGAS	(2) NRT	High Contamination
	R8FBRRNB21	3-1/2"	7-7/8"	4-3/8"	1/4"	0.062	1-1/2"	5/8"	(1) NB21	----	Under Water
	R8FBRRLU1	3-1/2"	7-7/8"	4-3/8"	1/4"	0.062	1-3/8"	1/2"	(2) BGAS	(2) NRT	High Contamination
	R8FBRRLU2	3-1/2"	7-7/8"	4-3/8"	1/4"	0.062	1-3/8"	5/8"	(2) BGAS	(2) NRT	High Contamination
	R5F4BRRCP2	4"	5"	2-3/8"	1/4"	0.062	2"	5/8"	(2) BGAS	(2) NRT	High Contamination
	R5F4BRRCNB21	4"	5"	2-3/8"	1/4"	0.062	1-1/2"	5/8"	(1) NB21	----	Under Water
	R5F4BRRCU1	4"	5"	2-3/8"	1/4"	0.062	1-3/8"	1/2"	(2) BGAS	(2) NRT	High Contamination
	R5F4BRRCU2	4"	5"	2-3/8"	1/4"	0.062	1-3/8"	5/8"	(2) BGAS	(2) NRT	High Contamination
	R5F4BRRCU3	4"	5"	2-3/8"	1/4"	0.062	1-3/8"	3/4"	(2) BGAS	(2) NRT	High Contamination

	PART NUMBER	WHEEL	FLANGE	TOTAL	FLANGE	STANDOFF	STANDOFF	THROUGH	BEARING	AUXILIARY	APPLICATION
		DIAMETER	DIAMETER	WIDTH	WIDTH	LENGTH	DIAMETER	HOLE		SEAL	
		A	B	C	D	E	F	G	H		
	R6F4BRRNB21	4"	6-1/2"	2-3/8"	1/4"	0.062	1-1/2"	5/8"	(1) NB21	----	Under Water
	R6F4BRRP2	4"	6-1/2"	2-3/8"	1/4"	0.062	2"	5/8"	(2) BGAS	(2) NRT	High Contamination
	R6F4BRRU1	4"	6-1/2"	2-3/8"	1/4"	0.062	1-3/8"	1/2"	(2) BGAS	(2) NRT	High Contamination
	R6F4BRRU2	4"	6-1/2"	2-3/8"	1/4"	0.062	1-3/8"	5/8"	(2) BGAS	(2) NRT	High Contamination
	R6F4BRRU3	4"	6-1/2"	2-3/8"	1/4"	0.062	1-3/8"	3/4"	(2) BGAS	(2) NRT	High Contamination
	R8F4BRRP2	4"	7-7/8"	2-3/8"	1/4"	0.062	2"	5/8"	(2) BGAS	(2) NRT	High Contamination
	R8F4BRRU2	4"	7-7/8"	2-3/8"	1/4"	0.062	1-3/8"	5/8"	(2) BGAS	(2) NRT	High Contamination
	R6F5BRR-1	4-1/2"	6-1/2"	2-3/8"	1/4"	----	----	1" Shaft Mount	(2) BGF	----	Moderate Contamination
	R6F5BRRP2	4-1/2"	6-1/2"	2-3/8"	1/4"	0.062	2"	5/8"	(2) BGAS	(2) NRT	High Contamination
	R6F5BRRU1	4-1/2"	6-1/2"	2-3/8"	1/4"	0.062	1-3/8"	1/2"	(2) BGAS	(2) NRT	High Contamination
	R6F5BRRU2	4-1/2"	6-1/2"	2-3/8"	1/4"	0.062	1-3/8"	5/8"	(2) BGAS	(2) NRT	High Contamination
	R6F5BRRU3	4-1/2"	6-1/2"	2-3/8"	1/4"	0.062	1-3/8"	3/4"	(2) BGAS	(2) NRT	High Contamination
	R8F5BRRU2	4-1/2"	7-7/8"	2-3/8"	1/4"	0.062	1-3/8"	5/8"	(2) BGAS	(2) NRT	High Contamination
	R25DNRR/BRG	6-9/16"	9-1/2"	2-1/2"	5/16"	----	----	----	(2) BGAS	(2) NRT	High Contamination
	R25DNRRP2	6-9/16"	9-1/2"	2-1/2"	5/16"	0.08	2"	5/8"	(2) BGAS	(2) NRT	High Contamination
	R25DNRR1	6-9/16"	9-1/2"	2-1/2"	5/16"	0.08	2"	1/2"	(2) BGAS	(2) NRT	High Contamination
	R25DNRR2	6-9/16"	9-1/2"	2-1/2"	5/16"	0.08	2"	5/8"	(2) BGAS	(2) NRT	High Contamination
	R25DNRR3	6-9/16"	9-1/2"	2-1/2"	5/16"	0.08	2"	3/4"	(2) BGAS	(2) NRT	High Contamination

BEARING INFORMATION

BGA - A 52MM (6205) Bearing used in high speed applications

BGAS - A 52MM (6205) Bearing used in low to moderate speed applications where high contamination is present

BGF - A 52MM Collar locking bearing used in low to moderate speed applications where moderate contamination is present (used only for 1" shaft mounts)

BGBS - A 40MM (6203) Bearing used in low to moderate speed applications where high contamination is present

BGB - A 40MM (6203) Bearing used in high speed applications

NB21 - A fixed bearing used in underwater applications

AUXILIARY SEAL INFORMATION

NRT - An auxiliary bearing seal that provides excellent protection in high contamination areas to greatly improve bearing life. The NRT seal has a low friction coefficient, providing low bearing drag.



DOUBLE FLANGED SERIES - STEEL

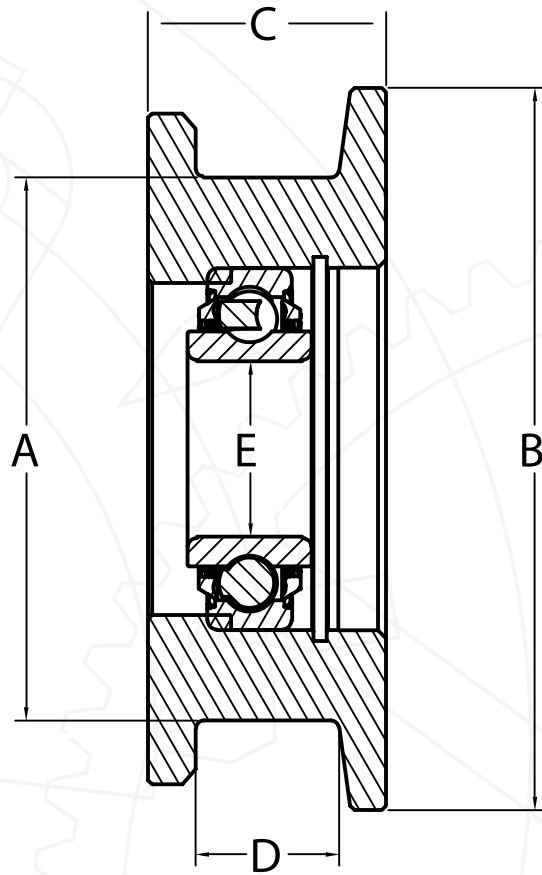

- A: Wheel Diameter
- B: Flange Diameter
- C: Wheel Width
- D: Between Flanges
- E: Through Hole

BEARING INFORMATION

BGA - A 52MM (6205) Bearing used in high speed applications

BGAS - A 52MM (6205) Bearing used in low to moderate speed applications where high contamination is present

BGF - A 52MM Collar locking bearing used in low to moderate speed applications where moderate contamination is present (used only for 1" shaft mounts)

BGBS - A 40MM (6203) Bearing used in low to moderate speed applications where high contamination is present

BGB - A 40MM (6203) Bearing used in high speed applications

NB21 - A fixed bearing used in underwater applications

AUXILIARY SEAL INFORMATION

NRT - An auxiliary bearing seal that provides excellent protection in high contamination areas to greatly improve bearing life. The NRT seal has a low friction coefficient, providing low bearing drag.

	PART NUMBER	WHEEL DIAMETER	FLANGE DIAMETER	WHEEL WIDTH	BETWEEN FLANGES	THROUGH HOLE	BEARING	APPLICATION
		A	B	C	D	E	F	
 Hardened Steel Body	HP574ASSY	4-1/4"	5-1/4" & 5-5/8"	1-7/8"	1-1/8"	35MM (BRG)	(1) BGLP	LOW RPM/HIGH LOAD
 Hardened Steel Body	HP575ASSY	4-1/4"	5-3/8"	1-7/8"	1-1/8"	35MM (BRG)	(1) BGLP	LOW RPM/HIGH LOAD
 Hardened Steel Body	HP576ASSY	4-1/2"	5-5/8" & 5-7/8"	1-7/8"	1-1/8"	35MM (BRG)	(1) BGLP	LOW RPM/HIGH LOAD
 Hardened Steel Body	HP577ASSY	5-3/4"	6-3/4"	2"	1-1/8"	35MM (BRG)	(1) BGLP	LOW RPM/HIGH LOAD
 Hardened Steel Body	HP578ASSY	5-3/4"	6-3/4" & 7"	2"	1-1/8"	35MM (BRG)	(1) BGLP	LOW RPM/HIGH LOAD
 Hardened Steel Body	HP579ASSY	10"	11"	2"	1-1/8"	35MM (BRG)	(1) BGLP	LOW RPM/HIGH LOAD
 Hardened Steel Body	HP580ASSY	9"	10"	2"	1-1/8"	35MM (BRG)	(1) BGLP	LOW RPM/HIGH LOAD

NOTES | DRAWINGS

Blank area for notes and drawings.

CONE ROLLERS

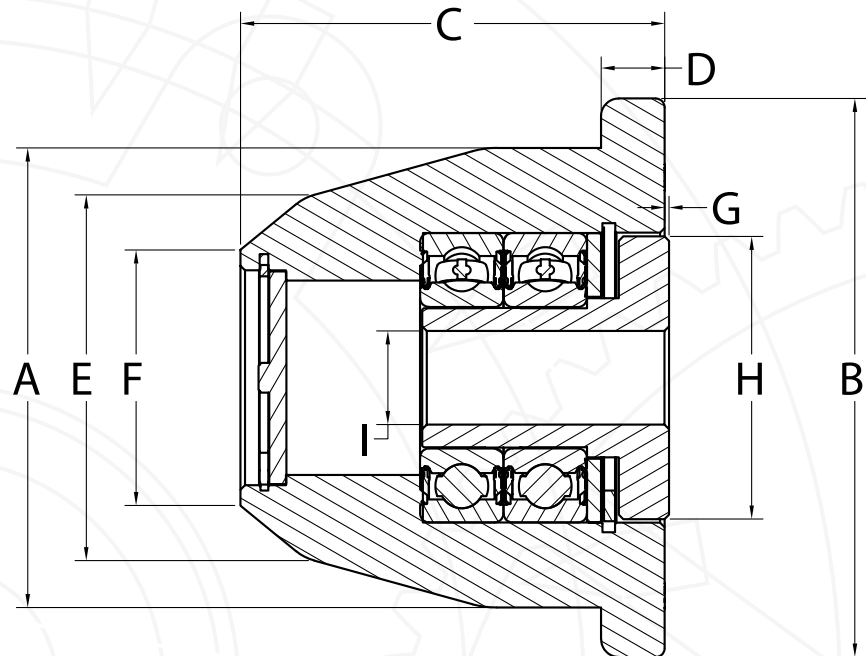

- A: Wheel Diameter
- B: Flange Diameter
- C: Total Width
- D: Flange Width
- E: Taper (1) Diameter
- F: Taper (2) Diameter
- G: Standoff Length
- H: Standoff Diameter
- I: Through Hole

BEARING INFORMATION

BGA - A 52MM (6205) Bearing used in high speed applications

BGAS - A 52MM (6205) Bearing used in low to moderate speed applications where high contamination is present

BGF - A 52MM Collar locking bearing used in low to moderate speed applications where moderate contamination is present (used only for 1" shaft mounts)

BGBS - A 40MM (6203) Bearing used in low to moderate speed applications where high contamination is present



BGB - A 40MM (6203) Bearing used in high speed applications

NB21 - A fixed bearing used in underwater applications

AUXILIARY SEAL INFORMATION

NRT - An auxiliary bearing seal that provides excellent protection in high contamination areas to greatly improve bearing life. The NRT seal has a low friction coefficient, providing low bearing drag.

	PART NUMBER	WHEEL DIAMETER	FLANGE DIAMETER	TOTAL WIDTH	FLANGE WIDTH	TAPER (1) DIAMETER	TAPER (2) DIAMETER	STANDOFF LENGTH	STANDOFF DIAMETER	THROUGH HOLE	BEARING	AUXILIARY SEAL	APPLICATION
		A	B	C	D	E	F	G	H	I			
Hardened Steel Body 	R25CNS2	3-1/2"	4-3/4"	3"	5/8"	3-1/4"	1-13/16"	0.05	2"	5/8"	(2)BGAS	(1)NRT (1)DC150	High Contamination
Hardened Steel Body 	R25SNRS1	3-1/2"	4-3/4"	3"	3/8"	----	1-13/16"	0.05	2"	1/2"	(2)BGAS	(1)NRT (1)DC150	High Contamination
	R25SNRS2	3-1/2"	4-3/4"	3"	3/8"	----	1-13/16"	0.05	2"	5/8"	(2)BGAS	(1)NRT (1)DC150	High Contamination
Hardened Steel Body 	R25SNS1	3-1/2"	4-3/4"	3"	5/8"	----	1-13/16"	0.05	2"	1/2"	(2)BGAS	(1)NRT (1)DC150	High Contamination
	R25SNS2	3-1/2"	4-3/4"	3"	5/8"	----	1-13/16"	0.05	2"	5/8"	(2)BGAS	(1)NRT (1)DC150	High Contamination
	R25SNS3	3-1/2"	4-3/4"	3"	5/8"	----	1-13/16"	0.05	2"	3/4"	(2)BGAS	(1)NRT (1)DC150	High Contamination
Hardened Steel Body 	R25TNS1	3-1/2"	4"	3"	5/8"	----	1-13/16"	0.05	2"	1/2"	(2)BGAS	(1)NRT (1)DC150	High Contamination
	R25TNS2	3-1/2"	4"	3"	5/8"	----	1-13/16"	0.05	2"	5/8"	(2)BGAS	(1)NRT (1)DC150	High Contamination
Hardened Steel Body 	R25TXNS1	3-1/2"	7-15/16"	3"	5/8"	----	1-13/16"	0.05	2"	1/2"	(2)BGAS	(1)NRT (1)DC150	High Contamination
	R25TXNS2	3-1/2"	7-15/16"	3"	5/8"	----	1-13/16"	0.05	2"	5/8"	(2)BGAS	(1)NRT (1)DC150	High Contamination
Hardened Steel Body 	R5FBRS1	3-1/2"	5"	3"	3/8"	----	2-1/2"	0.05	2"	1/2"	(2)BGAS	(1)NRT (1)DC150	High Contamination
	R5FBRS2	3-1/2"	5"	3"	3/8"	----	2-1/2"	0.05	2"	5/8"	(2)BGAS	(1)NRT (1)DC150	High Contamination
	R5FBRS3	3-1/2"	5"	3"	3/8"	----	2-1/2"	0.05	2"	3/4"	(2)BGAS	(1)NRT (1)DC150	High Contamination
Hardened Steel Body 	R5FSHU1	3-1/2"	5"	2-3/8"	1/4"	----	3"	0.062	1-3/8"	1/2"	(2)BGAS	(2) NRT	High Contamination
	R5FSHU2	3-1/2"	5"	2-3/8"	1/4"	----	3"	0.062	1-3/8"	5/8"	(2)BGAS	(2) NRT	High Contamination
	R5FSHU3	3-1/2"	5"	2-3/8"	1/4"	----	3"	0.062	1-3/8"	3/4"	(2)BGAS	(2) NRT	High Contamination
Hardened Steel Body 	R25NS1	3-1/4"	4"	3"	1/2"	2-9/16"	1-13/16"	0.05	2"	1/2"	(2)BGAS	(1)NRT (1)DC150	High Contamination
	R25NS2	3-1/4"	4"	3"	1/2"	2-9/16"	1-13/16"	0.05	2"	5/8"	(2)BGAS	(1)NRT (1)DC150	High Contamination
	R25NS3	3-1/4"	4"	3"	1/2"	2-9/16"	1-13/16"	0.05	2"	3/4"	(2)BGAS	(1)NRT (1)DC150	High Contamination
Hardened Steel Body 	R25WNS1	3-1/4"	4"	3"	1/2"	2-1/2"	1-13/16"	0.05	2"	1/2"	(2)BGAS	(1)NRT (1)DC150	High Contamination
	R25WNS2	3-1/4"	4"	3"	1/2"	2-1/2"	1-13/16"	0.05	2"	5/8"	(2)BGAS	(1)NRT (1)DC150	High Contamination
Hardened Steel Body 	R383R2	3-3/4"	6-1/2"	2-1/2"	3/8"	----	2-1/8"	0.062	2"	5/8"	(2)BGAS	(2) NRT	High Contamination
	R383R3	3-3/4"	6-1/2"	2-1/2"	3/8"	----	2-1/8"	0.062	2"	3/4"	(2)BGAS	(2) NRT	High Contamination
	R383U1	3-3/4"	6-1/2"	2-1/2"	3/8"	----	2-1/8"	0.062	1-3/8"	1/2"	(2)BGAS	(2) NRT	High Contamination
	R383U2	3-3/4"	6-1/2"	2-1/2"	3/8"	----	2-1/8"	0.062	1-3/8"	5/8"	(2)BGAS	(2) NRT	High Contamination
Hardened Steel Body 	R5000R2	3-3/8"	5"	2-1/2"	5/16"	----	2-9/16"	0.062	2"	5/8"	(2)BGAS	(2) NRT	High Contamination
	R5000U1	3-3/8"	5"	2-1/2"	5/16"	----	2-9/16"	0.062	1-3/8"	1/2"	(2)BGAS	(2) NRT	High Contamination
	R5000U2	3-3/8"	5"	2-1/2"	5/16"	----	2-9/16"	0.062	1-3/8"	5/8"	(2)BGAS	(2) NRT	High Contamination
	R5000U3	3-3/8"	5"	2-1/2"	5/16"	----	2-9/16"	0.062	1-3/8"	3/4"	(2)BGAS	(2) NRT	High Contamination

	PART NUMBER	WHEEL	FLANGE	TOTAL	FLANGE	TAPER (1)	TAPER (2)	STANDOFF	STANDOFF	THROUGH	BEARING	AUXILIARY	APPLICATION
		DIAMETER	DIAMETER	WIDTH	WIDTH	DIAMETER	DIAMETER	LENGTH	DIAMETER	HOLE		SEAL	
		A	B	C	D	E	F	G					
Hardened Steel Body 	R3876R1	4-1/2"	6"	3-1/8"	1/2"	----	2-13/16"	0.062	2"	1/2"	(2)BGAS	(2) NRT	High Contamination
	R3876R2	4-1/2"	6"	3-1/8"	1/2"	----	2-13/16"	0.062	2"	5/8"	(2)BGAS	(2) NRT	High Contamination
	R3876R3	4-1/2"	6"	3-1/8"	1/2"	----	2-13/16"	0.062	2"	3/4"	(2)BGAS	(2) NRT	High Contamination
	R3876U2	4-1/2"	6"	3-1/8"	1/2"	----	2-13/16"	0.062	1-3/8"	5/8"	(2)BGAS	(2) NRT	High Contamination
Hardened Steel Body 	R603R2	5"	6-1/2"	2-1/8"	3/8"	----	4-3/4"	0.062	2"	5/8"	(2)BGAS	(2) NRT	High Contamination
	R603R3	5"	6-1/2"	2-1/8"	3/8"	----	4-3/4"	0.062	2"	3/4"	(2)BGAS	(2) NRT	High Contamination
	R603U2	5"	6-1/2"	2-1/8"	3/8"	----	4-3/4"	0.062	1-3/8"	5/8"	(2)BGAS	(2) NRT	High Contamination

NOTES | DRAWINGS

BEARING INFORMATION

BGA - A 52MM (6205) Bearing used in high speed applications

BGAS - A 52MM (6205) Bearing used in low to moderate speed applications where high contamination is present

BGF - A 52MM Collar locking bearing used in low to moderate speed applications where moderate contamination is present (used only for 1" shaft mounts)

BGBS - A 40MM (6203) Bearing used in low to moderate speed applications where high contamination is present

BGB - A 40MM (6203) Bearing used in high speed applications

NB21 - A fixed bearing used in underwater applications

AUXILIARY SEAL INFORMATION

NRT - An auxiliary bearing seal that provides excellent protection in high contamination areas to greatly improve bearing life. The NRT seal has a low friction coefficient, providing low bearing drag.

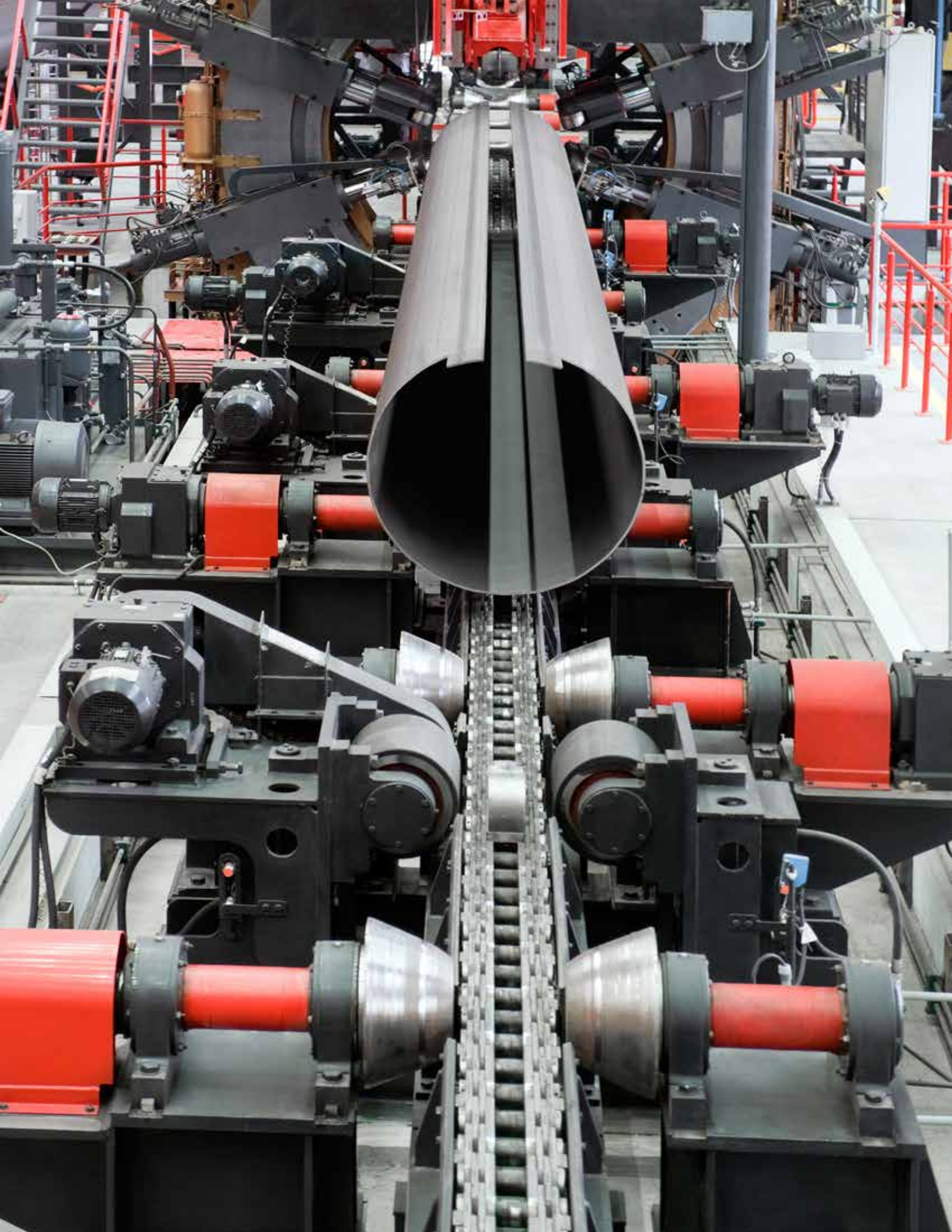

— Additional Products —



Idler Wheel Rollers



Sprockets



Chain Tensioners



Chain Idlers



Torque Limiter Clutches



Articulating Hitches



Bearing Protectors



Friction Drive Rollers



Shakers



CNH Enhancements



Steel Pillow Blocks

TEROG MANUFACTURING



Terog Manufacturing builds quality Black Ace® parts for a wide variety of original equipment, as well as a large selection of replacement parts. Family-owned and -operated since 1971, Terog Manufacturing is a specialist in improving equipment performance and profitability.



blackaceparts.com 387 Atlantic Ave. | P.O. Box 587 | Stephen, MN 56757 218.478.3395 | 800.423.3918